

# Table of Contents

<b>1.</b>	<b>SAFETY PRECAUTIONS AND WARNINGS.....</b>	<b>1</b>
<b>2.</b>	<b>USING THE TEST TOOL .....</b>	<b>2</b>
<b>2.1</b>	<b>TOOL DESCRIPTION .....</b>	<b>2</b>
<b>2.2</b>	<b>SPECIFICATIONS.....</b>	<b>3</b>
<b>2.3</b>	<b>ACCESSORIES INCLUDED.....</b>	<b>3</b>
<b>2.4</b>	<b>GENERAL DESCRIPTION.....</b>	<b>4</b>
<b>2.5</b>	<b>POWER.....</b>	<b>4</b>
<b>2.6</b>	<b>QUICK SELF-TEST.....</b>	<b>4</b>
<b>2.7</b>	<b>CIRCUIT BREAKER.....</b>	<b>6</b>
<b>2.8</b>	<b>WORK MODE.....</b>	<b>6</b>
<b>3.</b>	<b>TEST APPLICATIONS.....</b>	<b>9</b>
<b>3.1</b>	<b>VOLTAGE &amp; POLARITY TESTING.....</b>	<b>9</b>
<b>3.2</b>	<b>CONTINUITY TESTING.....</b>	<b>9</b>
<b>3.3</b>	<b>SIGNAL CIRCUIT TESTING.....</b>	<b>11</b>
<b>3.4</b>	<b>ACTIVATING COMPONENTS IN YOUR HAND.....</b>	<b>12</b>
<b>3.5</b>	<b>TESTING TRAILER LIGHTS AND CONNECTIONS.....</b>	<b>13</b>
<b>3.6</b>	<b>ACTIVATING COMPONENTS IN THE VEHICLE.....</b>	<b>14</b>
<b>3.7</b>	<b>ACTIVATING COMPONENTS W/GROUND.....</b>	<b>15</b>
<b>3.8</b>	<b>CHECKING FOR BAD GROUND CONTACTS.....</b>	<b>16</b>
<b>3.9</b>	<b>FOLLOWING &amp; LOCATING SHORT CIRCUITS.....</b>	<b>17</b>
<b>3.10</b>	<b>RED/GREEN POLARITY LED.....</b>	<b>18</b>
<b>4.</b>	<b>TEST TOOL SPECIFICATIONS.....</b>	<b>19</b>
<b>5.</b>	<b>TEST TOOL KNOW-HOW.....</b>	<b>20</b>
<b>6.</b>	<b>WARRANTY AND SERVICE.....</b>	<b>22</b>
<b>6.1</b>	<b>LIMITED ONE YEAR WARRANTY.....</b>	<b>22</b>
<b>6.2</b>	<b>SERVICE PROCEDURES.....</b>	<b>22</b>

# 1. Safety Precautions and Warnings

**To prevent personal injury or damage to vehicles and/or the test tool, read this instruction manual first and observe the following safety precautions at a minimum whenever working on a vehicle:**

- Always perform automotive testing in a safe environment.
- Wear safety eye protection that meets ANSI standards.
- Keep clothing, hair, hands, tools, test equipment, etc. away from all moving or hot engine parts.
- Operate the vehicle in a well ventilated work area: Exhaust gases are poisonous.
- Put blocks in front of the drive wheels and never leave the vehicle unattended while running tests.
- Use extreme caution when working around the ignition coil, distributor cap, ignition wires and spark plugs. These components create hazardous voltages when the engine is running.
- Put the transmission in PARK (for automatic transmission) or NEUTRAL (for manual transmission) and make sure the parking brake is engaged.
- Keep a fire extinguisher suitable for gasoline/chemical/ electrical fires nearby.
- Don't connect or disconnect any test equipment while the ignition is on or the engine is running.
- Keep the tool dry, clean, free from oil/water or grease. Use a mild detergent on a clean cloth to clean the outside of the test tool, when necessary.
- When the power switch in the tool is depressed battery current/voltage is conducted directly to the tip which may cause sparks when contacting ground or certain circuits. Therefore the tool should NOT be used around flammables such as gasoline or its vapors. The spark of an energized tool could ignite these vapors. Use the same caution as you would when using an arc welder.

## 2. Using the Test Tool

### 2.1 Tool Description

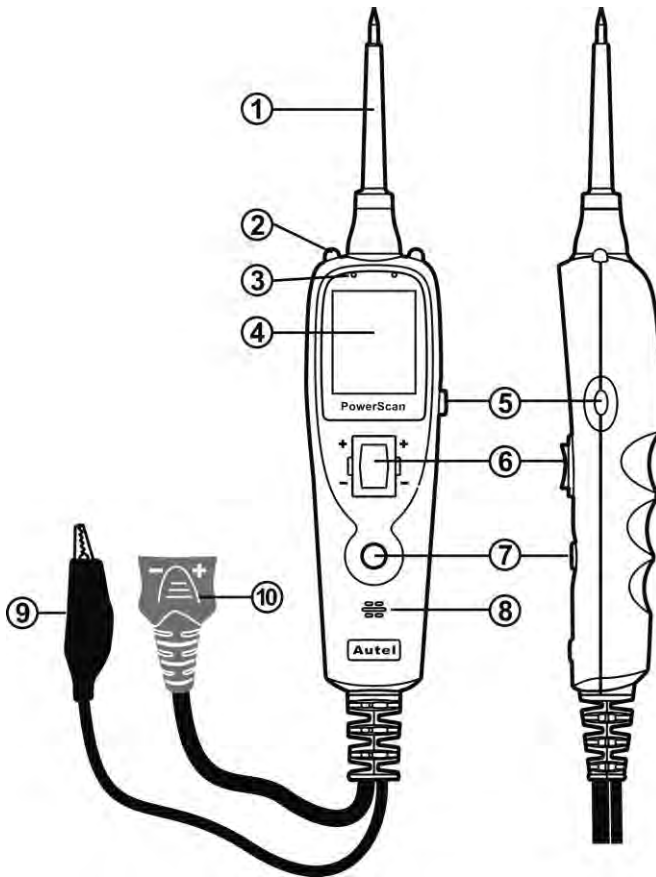

- ① **Probe Tip** – Contacts the circuit or component to be tested.
- ② **Head Lights** – Illuminates dark work areas or work areas at night. .
- ③ **Red/Green Polarity Indicator** – Identifies positive, negative or open circuits. The RED Indicator lights when the Probe Tip is

contacting a positive circuit. The GREEN Indicator lights when the Probe Tip is contacting a negative circuit.

- ④ **LCD Display** –Indicates test results.
- ⑤ **Circuit Breaker Reset** – Resets the tool when the Circuit Breaker is tripped.
- ⑥ **Power Switch** – Allows you to conduct a positive or negative battery current to the tip for activating and testing the function of electrical components.
- ⑦ **Mode Button** – Selects the work mode: AC voltage, DC voltage, resistance, tone.
- ⑧ **Speaker** – When the audio tone is turned on, a beep will be heard.
- ⑨ **Auxiliary Ground Lead** – Assists test as a ground lead.
- ⑩ **Adaptor** – Connects to the battery.

## 2.2 Specifications

- 1) Display: TFT color display (160 x 128 dpi)
- 2) Operating Temperature: 0 to 60°C (32 to 140 F°)
- 3) Storage Temperature: -40 to 70°C (-40 to 185 F°)
- 4) External Power: 12.0 or 24.0 V power provided via vehicle battery
- 5) Dimensions:

	<b>Length</b>	<b>Width</b>	<b>Height</b>
	126 mm (4.96")	46.5 mm (1.83")	35 mm (1.38")
6)	NW: 0.105kg (0.23lb),	GW: 0.726 kg(1.6lb)	

## 2.3 Accessories Included

- 1) User’s Manual.
- 2) Cigarette lighter adapter.
- 3) Battery hookup clips
- 4) Probe tip.
- 5) 20ft. extension cable.

- 6) Rugged blow molded case.

## 2.4 General Description

The tool is the best electrical tester for reducing diagnostic time in all 6- to 30-volt vehicle electrical systems. After a simple hook-up of the tool to the vehicle's battery, you can:

- determine at a glance if a circuit is positive, negative, or open without having to reconnect clips from one battery pole to another.
- test for continuity with its built-in auxiliary ground lead.
- by depressing the power switch, conduct a positive or negative battery current to the probe tip for testing the function of an electrical component without the use of jumper wires.
- test for poor ground contacts instantly without performing voltage drop tests. The tool is also short-circuit protected; its internal circuit breaker will trip if it becomes overloaded.
- follow and locate short circuits without wasting fuses. The tool's long cable allows you to test along the entire length of the vehicle without constantly searching for suitable vehicle grounds.

## 2.5 Power

The tool is powered via the vehicle battery. Connect the RED battery clamp to the POSITIVE terminal of the vehicle's battery, and the BLACK clamp to the NEGATIVE terminal. When the tool is first connected to a battery (power source), it will sound a beep and the Head Lights will be on to illuminate the test area of the probe tip.

## 2.6 Quick Self-Test

Before you test a circuit or component, be sure your tool is in good order by doing a quick self-test.

With the tool connected, perform a quick self-test. The power switch is a momentary rocker switch located on the tool's body. Flanking the switch are positive and negative markings.

Press the Power Switch forward to activate the tip with a positive voltage. The Red LED should light and the LCD display will read the battery voltage. If the tone feature is turned on, a high pitched tone will sound. Let go of the power switch and the LED will turn off and the high tone will cease.

Press the Power Switch rearward to activate the tip with a negative voltage. The Green LED should light and the LCD display will read the „0.0V“ (ground). If the tone feature is turned on, a low pitched tone will sound. Let go of the power switch and the LED will turn off and the low tone will cease.

Your tool is working correctly and is now ready for use. (Figure 1)

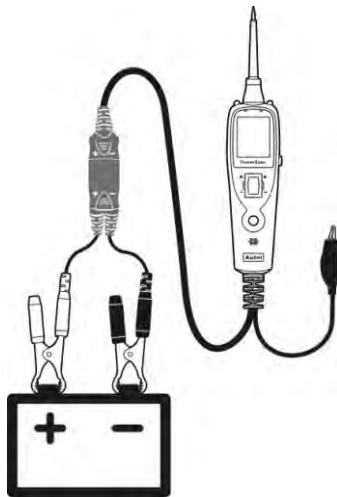

Figure 1

***IMPORTANT:*** When powering-up components, you can increase the life of power switch in the tool if you first press the switch, then

*contact the tip to the component. The arcing will take place at the tip instead of the contacts of the switch.*

## 2.7 Circuit Breaker

The tool is short-circuit protected. Its internal circuit breaker will trip if it becomes overloaded. The circuit breaker is a valuable test tool as well as a safety measure to protect the tool from overload.

When circuit breaker tripped, the LCD will display as below. (Figure 2) All other functions of the tool are still active, which means you can still probe a circuit and observe the voltage reading. When the circuit breaker is tripped, the tool will NOT be able to conduct battery current to the tip even when the power switch is pressed. Intentionally tripping the breaker and using the tool to probe can be considered an added precaution against accidental pressing of the power switch.

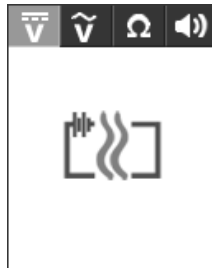

Figure 2

## 2.8 Work mode

There are four modes to diagnose the electrical systems, which can be accessed by depressing the Mode Button and cycling through each one.

### DC voltage

While the tool in this mode, contact the probe tip to a circuit, then the LCD display will read the DC voltage with a resolution of 0.1 volt. (Figure 3)



Figure 3

### **AC voltage**

While the tool in this mode, contact the probe tip to a circuit, then the LCD display will read the Max. voltage, the Min. voltage, frequency and duty cycle. ( Figure 4).

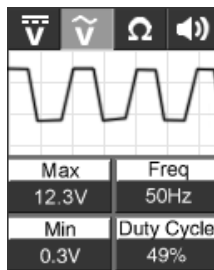

Figure 4

### **Resistance**

While the tool in this mode, contact the probe tip to a circuit, then the LCD display will read the resistance between the tip and auxiliary ground lead. (Figure 5)





Figure 5

## **Tone On/Off**

While the tool in this mode, just do a quick press of the mode button to toggle the tone on or off. While quickly pressing (a quick press and release) the mode button, if a short high beep is heard, this means the audio tone is turned on. If a short low beep is heard, the audio tone is turned off. (Figure 6)

This function is invaluable when working in bright areas where LED illumination alone is not sufficient. The audio feature may be disengaged when desired, such as for applications where the tool will be connected to circuits for long periods of time and the audio could become annoying.

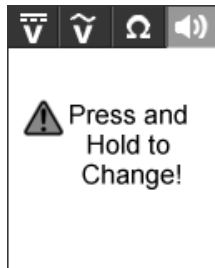

Figure 6

### 3. Test Applications

#### 3.1 Voltage & Polarity Testing

While the tool is in DC Voltage mode, contact the probe tip to a POSITIVE circuit. The red LED will light and the LCD displays the voltage with a resolution of 0.1V. If the beep is turned on, a high pitched tone will sound.

If contact the probe tip to a NEGATIVE circuit, the green LED will light and the LCD displays the voltage with a resolution of 0.1V. If the beep is turned on, a low pitched tone will sound.

If contact the probe tip to an OPEN circuit, neither of the LED will light.(Figure 7)

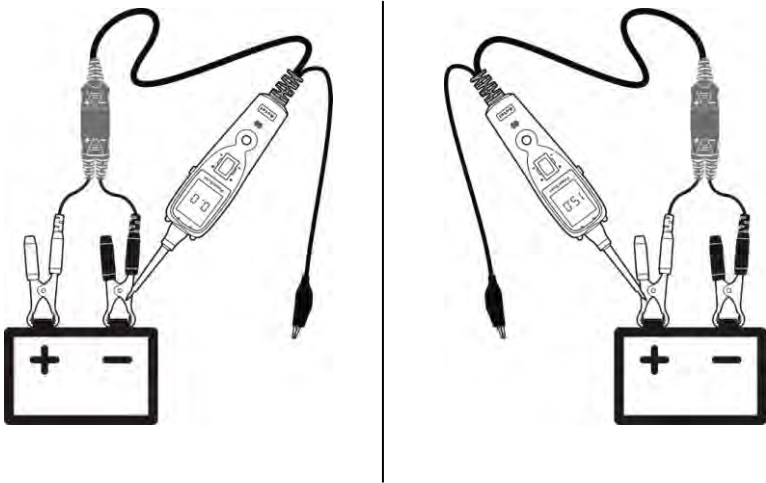

Figure 7

#### 3.2 Continuity Testing

While the tool is in Resistance mode, using the probe tip with chassis ground or the auxiliary ground lead, continuity can be tested on wires and components attached or disconnected from the vehicle's electrical system.

When the probe tip is contacting a good ground, the LCD will indicate "0.0Ω" and green LED will be on. If the tone feature is turned on, a low pitched tone will sound. (Figure 8)

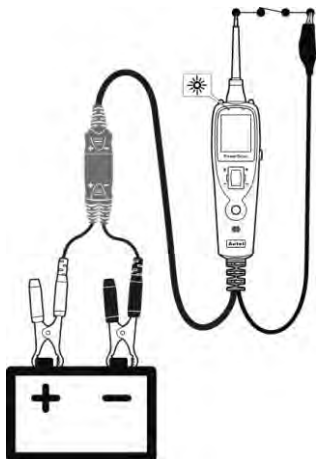

Figure 8

- In other cases, the LCD only indicates the resistance value. (Figure 9)



Figure 9

- If the resistance value is greater than 200k $\Omega$  , the LCD will show “0L”.

There is also another way to prove continuity of connections to ground or battery. Power up the connection using the power switch. If the circuit breaker trips you know that you have a good solid low resistance connection.

***NOTE: You can use the probe tip to pierce the plastic insulation on a wire. This means that you can test the circuit without disconnecting anything.***

### 3.3 Signal Circuit Testing

Once you extract a DTC from the vehicle and realize that troubleshooting begins with some kind of sensor circuit, there is a quick test you can perform to verify the code. Testing your sensor is easy while using the tool.

For example, you suspect there is a problem with your M.A.P. sensor circuit, then follow the procedure involved with testing this sensor:

- Set the tool in AC Voltage mode, using the probe tip with chassis ground or the auxiliary ground lead.
- Connect vacuum pump to MAP sensor.
- Contact the probe tip to the MAP sensor positive terminal and observe the LCD readings which should be a sine wave in normal condition.
- Apply vacuum.
- Release vacuum and observe the LCD readings. (Figure 10)

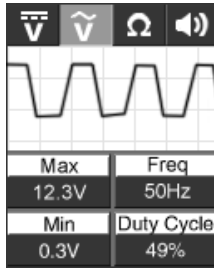

Figure 10

If the LCD readings are abnormal, there is a problem with this sensor.

### 3.4 Activating Components in Your Hand

While the tool is in DC Voltage mode, by using the probe tip in connection with the auxiliary ground lead, components can be activated right in your hand, thereby testing their functions.

Connect the auxiliary ground lead to the negative terminal or ground side of the component being tested. Then contact the probe tip to the positive terminal of the component, the green LED should light, indicating continuity through the component.

While keeping an eye on the green LED, quickly press and release the power switch forward. If the green LED went out and the red LED came on, you may proceed with further activation. Rock the power switch forward and hold it down to provide power to your component. With the power switch rocked forward, power will flow from the positive lead on the battery into the probe tip, through the tip into the component's positive terminal, into the component and out of the component, through the auxiliary ground lead and back into the tool, and back to the vehicle's battery's ground. (Figure 11)

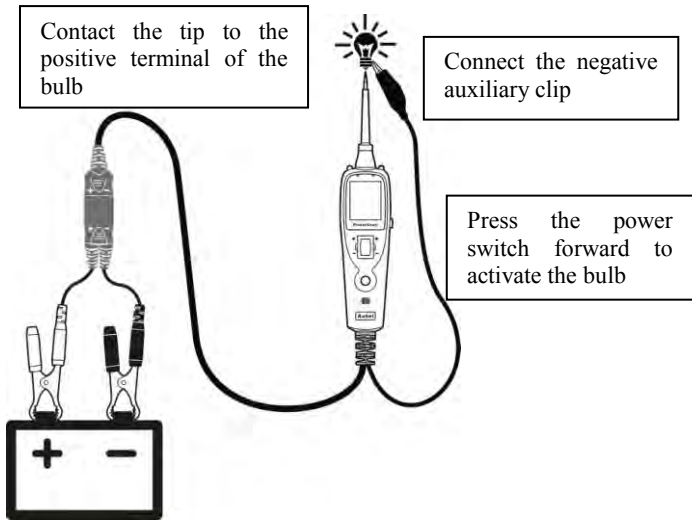

Figure 11

If the green LED went off at that instant or if the circuit breaker tripped, the tool has been overloaded. This could happen for the following reasons:

- The contact you are probing is a direct ground or negative voltage.
- The component you are testing is short-circuited.
- The component is a very high current component (i.e., starter motor).

If the circuit breaker is tripped, reset it by waiting for it to cool down (15 sec.) and then depressing the reset button.

### 3.5 Testing Trailer Lights and Connections

While the tool in DC Voltage mode, clip the auxiliary ground lead to the trailer ground, probe the contacts at the jack and then apply

voltage to the probe tip. This lets you check the function and orientation of the connector and trailer lights. (Figure 12)

If the circuit breaker tripped, that contact is likely a ground. Reset the circuit breaker by letting it cool down for 15 seconds and depressing the reset button until it clicks into place.

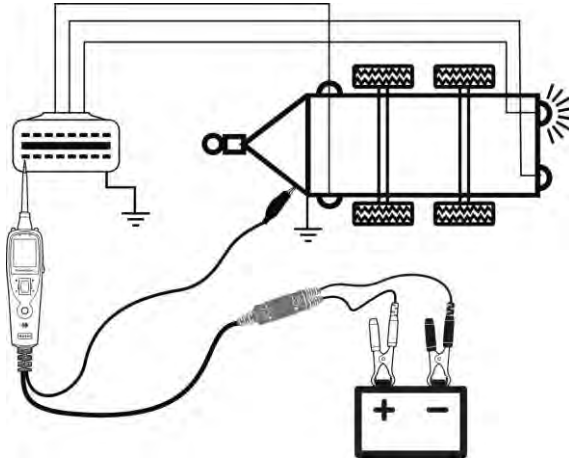

Figure 12

### 3.6 Activating Components in The Vehicle

While the tool in DC Voltage mode, contact the probe tip to the positive terminal of the component, the green LED should light, indicating continuity to ground. While observing the green LED, quickly depress and release the power switch forward. If the green LED went out and the red LED came on, you may proceed with further activation. (Figure 13) If the green LED went off at that instant or if the circuit breaker tripped, the tool has been overloaded. This could happen for the following reasons:

- The contact you are probing is a direct ground.
- The component you are testing is short-circuited.

- The component is a very high current component(i.e., starter motor).

If the circuit breaker is tripped, reset it by waiting for it to cool down (15 sec.) and then depressing the reset button.

***WARNING : Haphazardly applying voltage to certain circuits can cause damage to a vehicle's electronic components. Therefore, it is strongly advised to use the vehicle manufacturer's schematic and diagnosing procedure while testing.***

***NOTE : When powering up components, you can increase the life of power switch if you first press the switch, then contact the tip to the component. The arcing will take place at the tip instead of the contacts of the switch.***

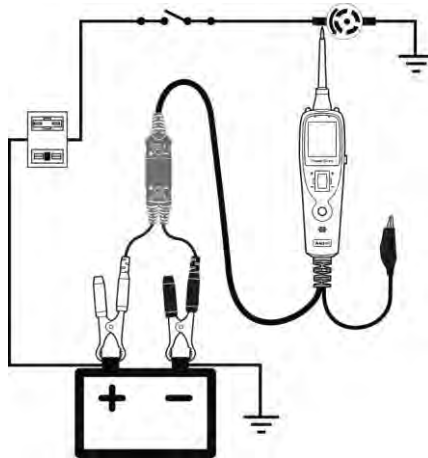

Figure 13

### 3.7 Activating Components w/Ground

While the tool in DC Voltage mode, contact the probe tip to the negative terminal of the component, the red LED should light. While observing the red LED, quickly depress and release the power switch rearward. If the red LED went out and the green LED came on, you



may proceed with further activation. (Figure 14) If the green LED went off at that instant or if the circuit breaker tripped, the tool has been overloaded. This could happen for the following reasons:

- The contact you are probing is a direct positive voltage.
- The component you are testing is short-circuited.
- The component is a very high current component (i.e., starter motor).

If the circuit breaker is tripped, reset it by waiting for it to cool down (15 sec.) and then depressing the reset button.

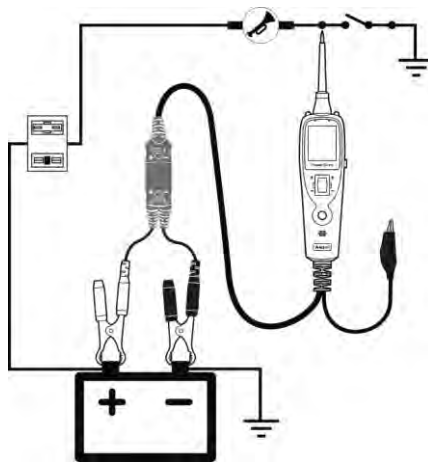

Figure 14

***WARNING : With this function, if you are contacting a protected circuit, a vehicle's fuse can be blown or tripped if you apply ground to it.***

### 3.8 Checking for Bad Ground Contacts

Probe the suspected ground wire or contact with the probe tip.

Observe the green LED. Depress the power switch forward then release. If the green LED went out and the red LED came on, this is not a true ground..

If the circuit breaker tripped, this circuit is more than likely a good ground. Keep in mind that high current components such as starter motors will also trip the circuit breaker.

### **3.9 Following & Locating Short Circuits**

In most cases a short circuit will appear by a fuse or a fusible link blowing or an electrical protection device tripping (i.e., a circuit breaker). This is the best place to begin the search.

- Remove the blown fuse from the fuse box.
- Use the probe tip to activate and energize each of the fuse contacts. The contact which trips the circuit breaker is the shorted circuit. Take note of this wire's identification code or color.
- Follow the wire as far as you can along the wiring harness.

Here is an example for this application.

- If you are following a short in the brake light circuit, you may know that the wire must pass through the wiring harness at the door sill. Locate the color-coded wire in the harness and expose it.
- Probe through the insulation with the probe tip, and depress the power switch forward to activate and energize the wire.
- If the circuit breaker tripped, you have verified the shorted wire. Cut the wire and energize each end with the probe tip. The wire end which trips the circuit breaker again is the shorted circuit and it will lead you to the shorted area.

- Follow the wire in the shorted direction and repeat this process until the short is located.

### **3.10 Red/Green Polarity LED**

The Red/Green Polarity LED lights up when the probe tip voltage matches the battery voltage within  $\pm 0.8$  volts. It is added information that could be valuable to the technician.

If the circuit you are testing is not within a 0.8 volt (plus or minus) of supply voltage, you will see the voltage reading on the LCD but you will not hear a tone or see a red or green LED. This tells you either you have a voltage drop in excess of 0.8 volt from battery voltage or you are probing a circuit that has an increase of a 0.8 volt or more over battery voltage.

To determine battery voltage, simply remove the tip from the circuit and press the power switch forward. Battery voltage will then be displayed on the LCD. The difference between the battery voltage and what is read on the circuit is either voltage drop or voltage increase. This allows you to determine a voltage drop without running back to check the battery. It's just another one of time saving feature the tool has.

## 4. Test Tool Specifications

DC voltage range : 0-65V +1 digit

Resistance range : 0 – 200 K $\Omega$

Frequency response of tone pass through  
0Hz to 10Khz.

---

### Circuit Breaker

Rating current: 1 – 10 Amp

### Testing Standard

- 100% current : no trip
- 150% current: trip in one hour
- 200% current: trip in 3-30 seconds.
- 300% current: trip in 0.5-4.0 seconds.

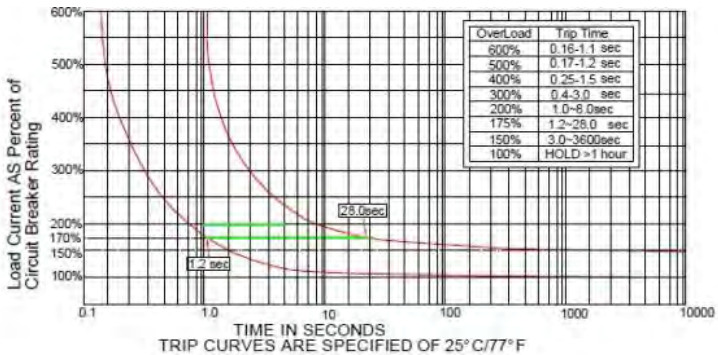

## 5. Test Tool Know-how

### 1) Is the PowerScan Probe Tester computer and air bag safe?

The tool LED and LCD pull no more than 1 milliamp of current, therefore when using it as a test light or multimeter it is computer and airbag safe. However, pressing the power switch is a different story. When you press the switch forward, you are conducting full battery current to the tip of the probe. There is a nice safety feature built into the tool. Simply connect the extra ground lead to the tool and press the power switch forward until it trips the circuit breaker. This will prevent power from going to the tip but still allow you to use the tool as a multimeter. When you are away from computer components, simply press the reset button and you are ready to power up again.

### 2) Why do I have no power at the tip when I am pressing the power switch forward but the red LED is on?

The power switch goes through a lot. It is one of the few things that go wrong with the tool. The switch is a consumable that needs to be replaced on occasion. We have made it real simple to not only change it but also buy a new switch. The switch can be snapped out and replaced in seconds.

You can buy switches from your Autel authorized tool supplier.

The tool with the Rocker Switch slots makes it easy to replace a worn switch in the field without having to send it in for repair.

Power Switch replacement procedure:

- Remove the worn switch with a pry tool. Be careful when applying force. (Figure 15)

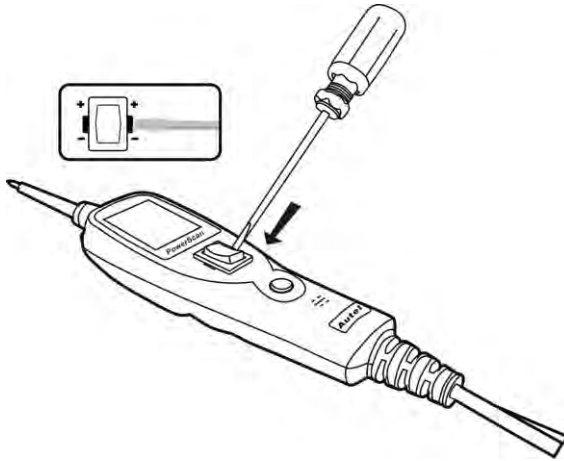

Figure 15

- Make sure to install the switch straight and press until flush with casing. (Figure 16)

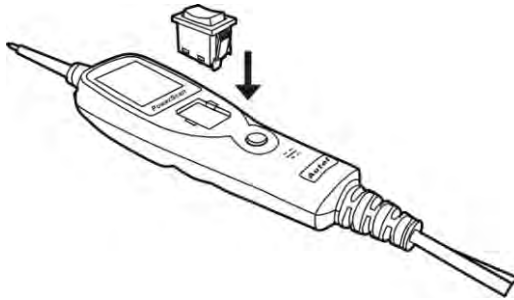

Figure 16

It is recommended when buying you get two. This will fix your tool now and give you a spare so you won't experience any down time in the future.

## **6. Warranty and Service**

### **6.1 Limited One Year Warranty**

Autel warrants to its customers that this product will be free from all defects in materials and workmanship for a period of one (1) year from the date of the original purchase, subject to the following terms and conditions:

- 1) The sole responsibility of Autel under the Warranty is limited to either the repair or, at the option of Autel, replacement of the test tool at no charge with Proof of Purchase. The sales receipt may be used for this purpose.
- 2) This warranty does not apply to damages caused by improper use, accident, flood, lightning, or if the product was altered or repaired by anyone other than the Manufacturer's Service Center.
- 3) Autel shall not be liable for any incidental or consequential damages arising from the use, misuse, or mounting of the test tool. Some states do not allow limitations on how long an implied warranty lasts, so the above limitations may not apply to you.
- 4) All information in this manual is based on the latest information available at the time of publication and no warranty can be made for its accuracy or completeness. Autel reserves the right to make changes at any time without notice.

### **6.2 Service Procedures**

If you have any questions, please contact your local store, distributor or visit our website at [www.auteltech.com](http://www.auteltech.com).

If it becomes necessary to return the test tool for repair, contact your local distributor for more information.